

# Roof sandwich panels EMR-EPS FARM 1050

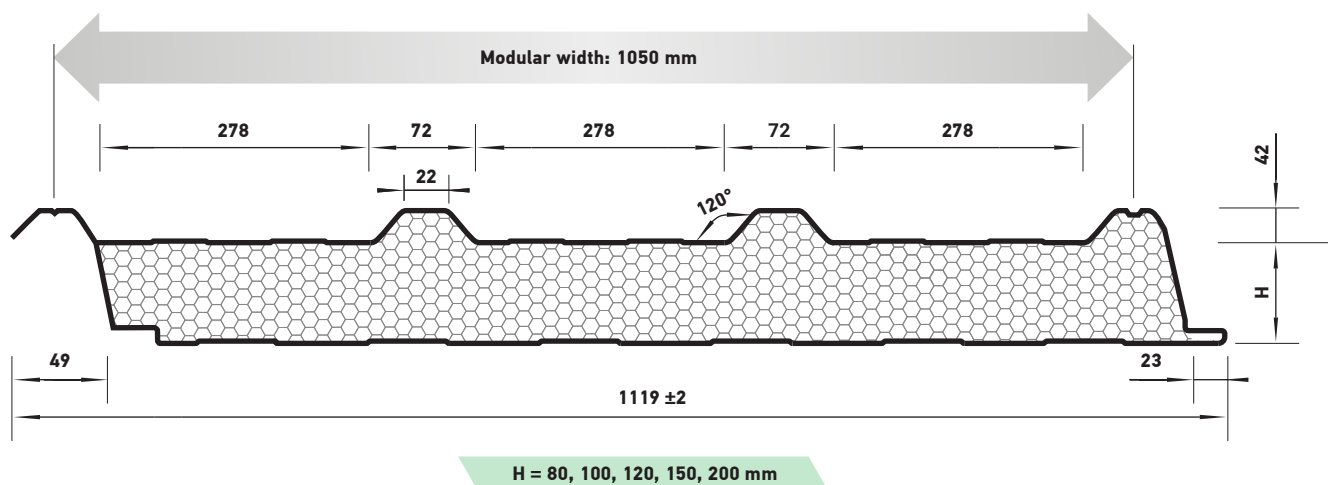

## Roof sandwich panels data sheet

Type of insulation (core)	EPS				
Insulant density [kg/m <sup>3</sup> ]	12,5				
Core thickness H and total thickness [mm]	80/122	100/142	120/162	150/192	200/242
Weight 1 m <sup>2</sup> (steel sheeting 0.5/0.5) [kg]	9.60	9.90	10.20	10.60	11.50
Panel length [mm]	2000 - 10000				
Modular width [mm]	1050 ± 2				
External steel sheeting thickness [mm]	0.5 / 0.6				
Internal steel sheeting thickness [mm]	0.4 / 0.5				
Declared value of thermal conductivity coefficient λ <sub>D</sub> [W/mK]	0.040				
Thermal transmittance (U-value) [W/m <sup>2</sup> K]	0.45	0.37	0.31	0.25	0.19
Classification of external fire exposure to roofs	B <sub>ROOF</sub> (t1)				
Coatings	- polyester, 25 μm (standard external coating) - FARM, 35 μm (internal coating, corrosion resistance C4)				



# Roof sandwich panels EMR-EPS FARM 1050

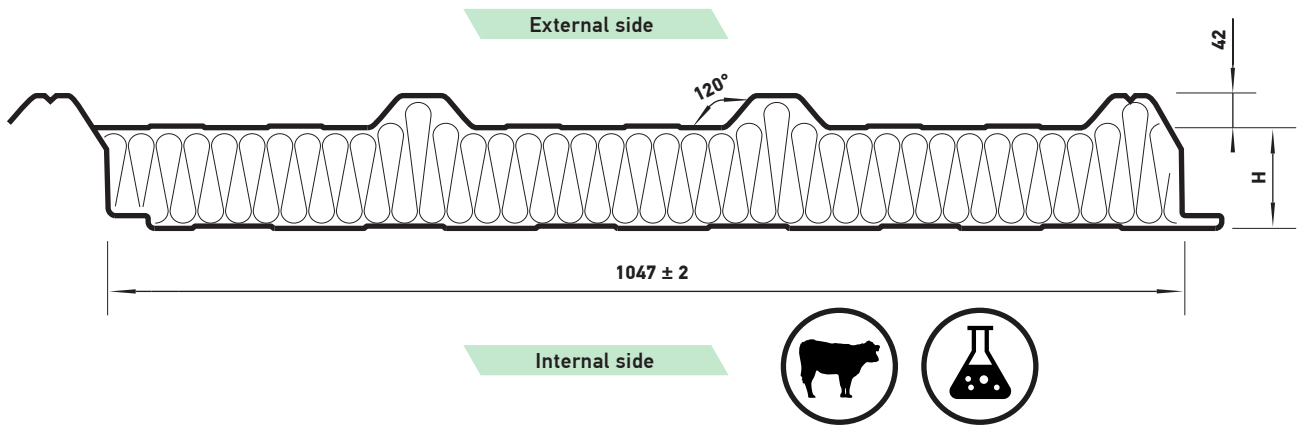

External side:

Internal side:

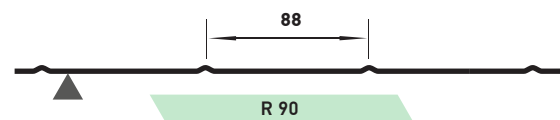
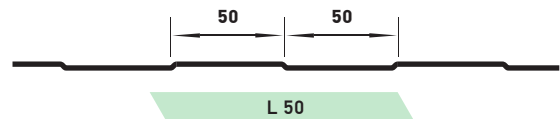
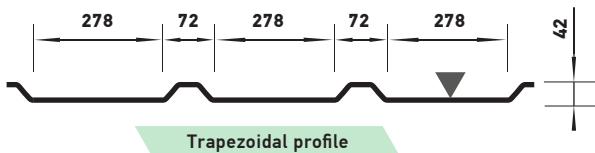

Smooth profile (G)



▼ - face

# Roof sandwich panels EMR-EPS FARM 1050

## Colours

### Standard RAL colours of the external sheeting PE 25 µm



RAL 1015



RAL 7035



RAL 9001



RAL 9002



RAL 9006



RAL 9010

### Nonstandard RAL colours of the external sheeting PE 25 µm



RAL 1002

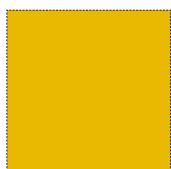

RAL 1021



RAL 3000

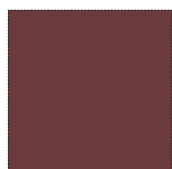

RAL 3011



RAL 3016



RAL 5010



RAL 5012



RAL 6029



RAL 7016

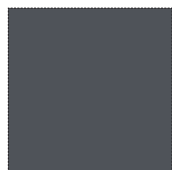

RAL 7024



RAL 8017



RAL 9007

### RAL colours of the external sheeting PE 25 µm on demand



RAL 1018

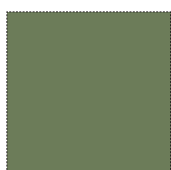

RAL 6011



RAL 7040

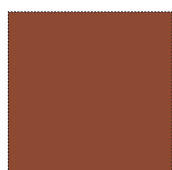

RAL 8004

### Standard RAL colours of the internal sheeting PE 25 µm



RAL 9002



RAL 9010

### Internal sheeting . FoodSafe



White

# Roof sandwich panels EMR-EPS FARM 1050

## Installation of sandwich panels

1. Thermal insulation core - EPS.
2. Steel facings 0.4 / 0.5 (standard) mm.
3. Self-drilling screw with EPDM washer for fixing sandwich panels with supporting structure.
4. Self-drilling screw with EPDM washer for fixing sandwich panels with each other..

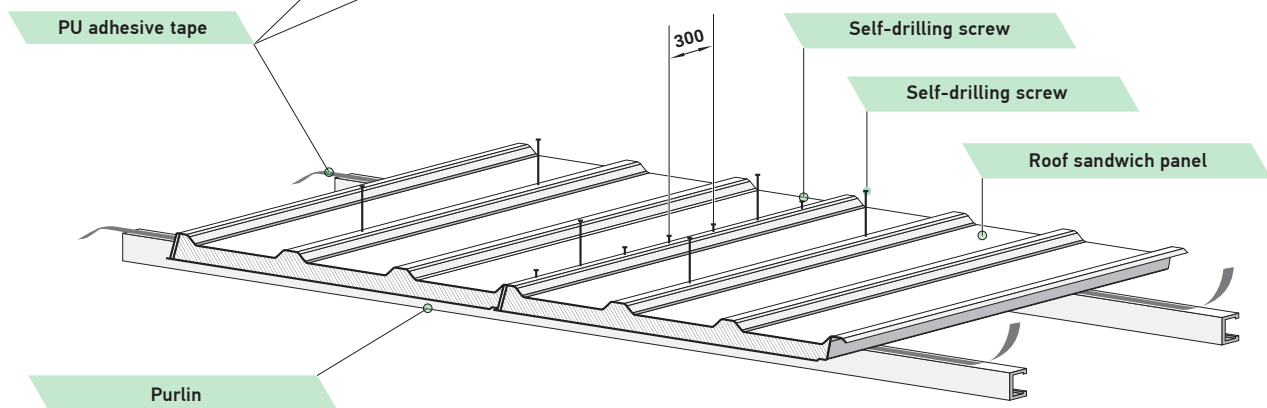
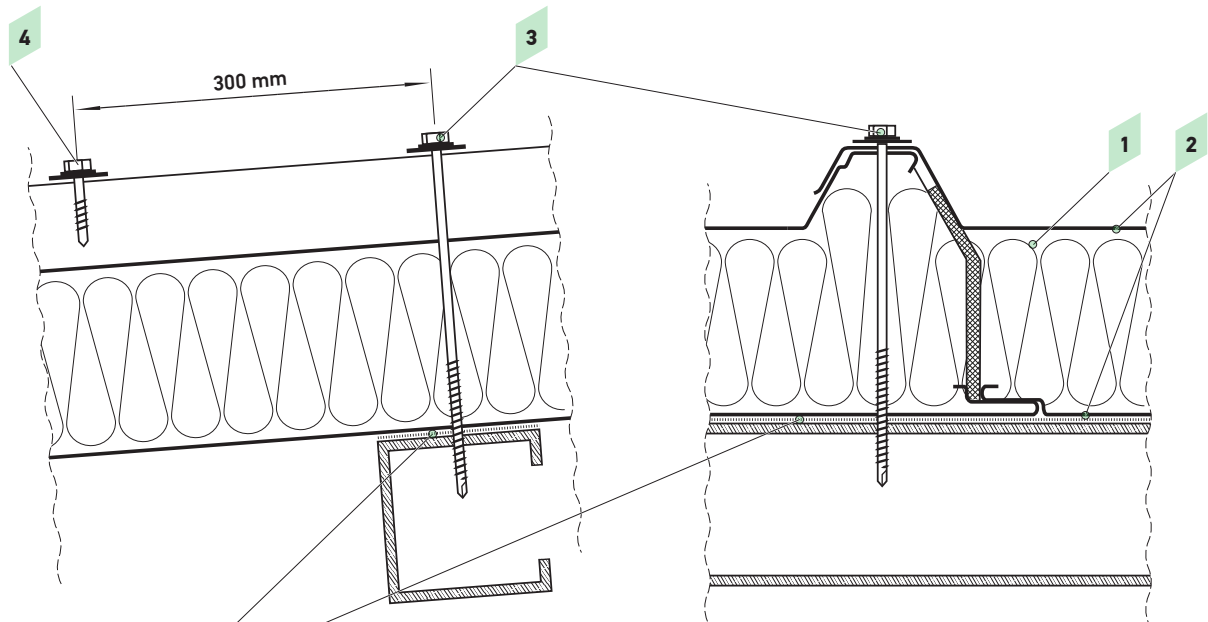

Installation of middle panels

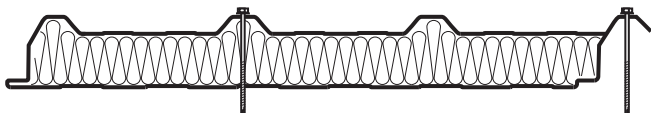

Fixing the panels to the ridge beam

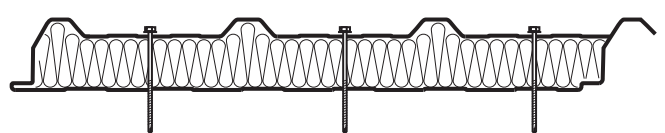

- Installation of the first and second panel in each row
- Installation of penultimate and last panel in each row
- Fixing the panels to the purlin at cornice

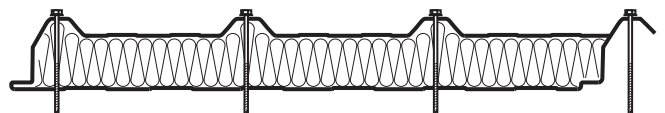

# Sandwich panel coating Farm 35 µm

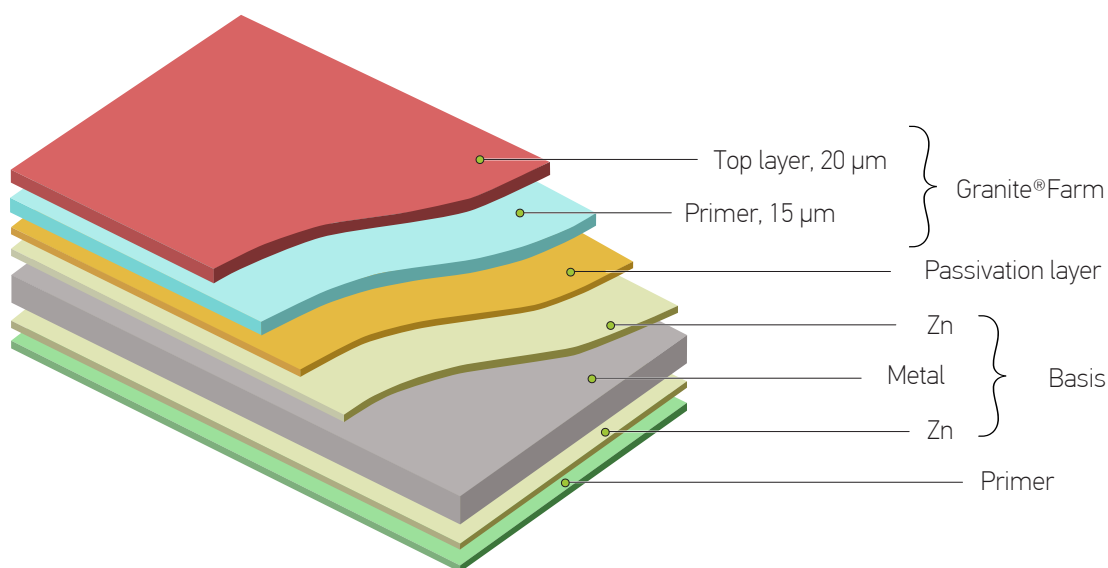

## Technical datasheet

Material	FARM coating	
Application	For indoor use only	FARM coating is specially designed for roofs, walls and ceilings of agricultural buildings
Description	Basis	Hot dip galvanized metal
	Nominal coating thickness	35 µm
	Composition	2 layers (primer, Granite® Farm paint)
	Color	White
	Glossy effect (60°)	30 GU (Medium)
	Surface appearance	Smooth
	Protective film	Yes - standard
Efficiency	Scratch resistance	>2000 g
	Surface hardness by the "pencil" method	HB līdz H
	Impact resistance	18 J
	Salt spray test Corrosion resistance	360 hours C3
	Resistance test in water vapor Corrosion resistance	1500 hours C4
	Resistance to ammonia	Very good
	Resistance to acidic / alkaline environment	Very good

